

GND-5621Cx-Dx (DUAL DIGIT LED DISPLAY)

GND-5621 Series

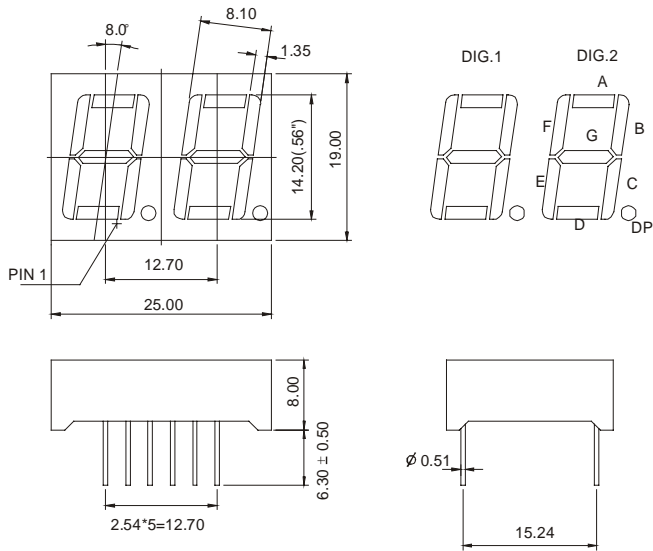

GND-5621Cx

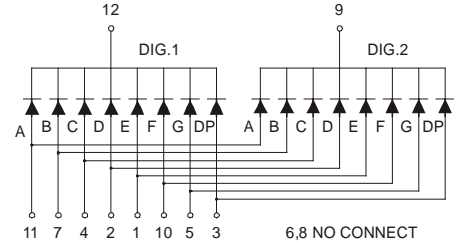

GND-5621Dx

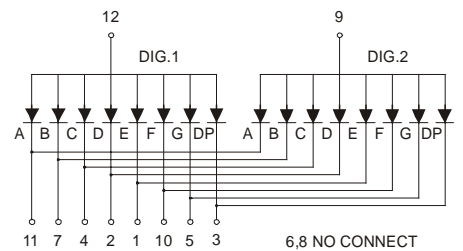

Features:

*0.56 INCH HIGH CHARACTER.

*EXCELLENT CHARACTER APPEARANCE.

*COMMON CATHODE OR COMMON ANODE.

*I.C. COMPATIBLE.

*LOW POWER CONSUMPTION.

Part Number	EMITTED COLOR		Common Cathode or Common Anode	Peak Wavelength (nm)	Vf (v) Typ	If (mA)	Intensity Per Segment (mcd)	
							Min.	Typ.
GND-5621CE	GaAsP/GaP	Hi.effi Red	Common Cathode	635	2.0	20	9	12
GND-5621CG	GaP	Green		565	2.1	20	8	11
GND-5621CY	GaAsP/GaP	Yellow		585	2.0	20	9	12
GND-5621CS	GaAlAs	Super Red		660	1.8	20	10	13
GND-5621CD	GaAlAs	Ultra Red		660	1.8	20	25	30
GND-5621CUE	AlGaInP	Ultra Red		625	2.0	20	30	35
GND-5621CUY	AlGaInP	Ultra Yellow		590	2.0	20	30	35
GND-5621DE	GaAsP/GaP	Hi.effi Red	Common Anode	635	2.0	20	9	12
GND-5621DG	GaP	Green		565	2.1	20	8	11
GND-5621DY	GaAsP/GaP	Yellow		585	2.0	20	9	12
GND-5621DS	GaAlAs	Super Red		660	1.8	20	10	13
GND-5621DD	GaAlAs	Ultra Red		660	1.8	20	25	30
GND-5621DUE	AlGaInP	Ultra Red		625	2.0	20	30	35
GND-5621DUY	AlGaInP	Ultra Yellow		590	2.0	20	30	35